



TECHNIKA

UK DVD Player

User Guide



DVDFAW08







User Guide

CONTENTS

INTRODUCTION	2	SPECIAL DVD FUNCTIONS.....	14
Safety is Important	2	Menu	14
IN THE BOX	2	Title.....	14
SAFETY INFORMATION	3	Subtitles	14
Power Source	3	Audio	14
General	3	Zoom	15
Cleaning.....	4	Search	15
Ventilation.....	4	Angle	16
Servicing.....	4	Repeat.....	16
Battery Disposal.....	4	A-B Repeat.....	16
How Do I Dispose of This Product?	5	On Screen Display (OSD).....	17
ELECTRICAL SAFETY	5	Program	17
PARTS IDENTIFICATION	6	PLAYING AUDIO CDs	18
Front View.....	6	Loading Audio CDs.....	18
Rear View.....	6	Selecting Tracks	18
Remote Control.....	7	Control During Playback	18
GETTING STARTED.....	8	Repeat.....	19
Connecting to the TV	8	A-B Repeat.....	19
The Remote Control	8	Program	19
Switching the DVD Player On and Off.....	9	Search	20
Screen Saver.....	9	PLAYING PHOTO CDs	20
INSERTING A DISC	10	Loading Photo CDs.....	20
DVD	10	Accessing the Photo CD contents	21
Audio CD	10	Control During Playback	21
Photo CD	10	Basic Controls.....	22
Compatible Discs.....	11	Language Setup	23
DVD PLAYER FUNCTIONS.....	12	Screen Setup	24
Playing DVDs	12	Audio Setup	26
Pause Play	12	Custom Setup	26
Stop Play	12	Default.....	28
Fast Forward/Reverse	12	HELP AND ADVICE.....	28
Skip to the Next/Previous Chapter.....	13	CARE AND MAINTENANCE	29
Step	13	Handling Discs.....	29
Mute.....	13	TECHNICAL SPECIFICATION.....	30
Volume.....	13	WARRANTY	30
PAL/NTSC	13		





TECHNIKA

DVD Player DVDFAW08

INTRODUCTION

Thank you for purchasing this Technika DVD player which has been designed and manufactured to give you many years of trouble-free service.

You may already be familiar with using a similar product but please take time to read these instructions which have been written to ensure you get the very best from your purchase.

Safety is Important

To ensure your safety and the safety of others, please read the Safety precautions **BEFORE** you operate this product.

Keep this information in a safe place for future reference.



WARNING! THIS PRODUCT UTILISES A CLASS 1 LASER. USE OF CONTROLS, ADJUSTMENTS OR PROCEDURE NOT LISTED IN THIS USER GUIDE MAY RESULT IN HAZARDOUS RADIATION EXPOSURE.

IN THE BOX

You will find the following:

- DVD Player
- User Guide
- Remote Control

NOTE: *If any of the items listed are damaged or missing, please contact the Tesco Electrical Helpline on 0845 456 6767.*



User Guide

SAFETY INFORMATION



 This symbol indicates that there are important operating and maintenance instructions in the literature accompanying this product.

 This symbol indicates that dangerous voltage constituting a risk of electric shock is present within this product.



These labels tell you that the product contains a laser component. Do not stare at the laser lens.

Power Source

- This product requires a 110-240V AC, 50/60Hz mains supply. Do not use any other supply.

General

- Position cables so that they cannot be walked on or pinched by other items placed on or against them.
- Do not use this product in humid or damp conditions.
- Do not allow this product to get wet.
- Do not expose this product to dripping or splashing.
- Do not place water filled objects such as vases on top of this product.
- Do not place naked flame sources, such as candles on top of this product.
- Do not install or operate near any heat sources such as radiators, stoves, or other apparatus that produce heat.
- Unplug this product during lightning storms or when unused for long periods of time.
- When the disc tray is open a safety interlock disconnects power to the laser. Do not override this safety interlock.



**TECHNIKA**

DVD Player DVDFAW08

- This product generates, uses and can radiate radio frequency energy and, if not installed and used in accordance with the instructions, may cause harmful interference to radio communication. However, this is no guarantee that interference will not occur in a particular installation. If this product does cause harmful interference to radio or television reception, which can be determined by turning the product off and on, the user is encouraged to try to correct the interference by one of the following measures:
 - Reorient or relocate the receiving antenna.
 - Increase the separation between the product and receiver.
 - Connect the product into an outlet on a circuit different from that to which the receiver is connected.
 - Consult the dealer or an experienced radio/TV technician for help.
- **Caution:** Changes or modifications not expressly approved by the manufacturer could void the user's authority to operate this product.
- **Caution:** Usage of controls or adjustments or performance of procedures other than those specified herein may result in hazardous exposure.

Cleaning

- Always unplug this product from the mains supply before you clean it.
- Do not use liquid or aerosol cleaners.
- This product should be cleaned with a soft, barely damp cloth.

Ventilation

- The slots and openings on this product are for ventilation purposes. Do not cover or block them as this could cause overheating.
- Never let children push anything into the slots or openings.

Servicing

- There are no user-serviceable parts in this product.
- If servicing is required, always refer to qualified service personnel.
- Always consult the dealer if you are ever in doubt about the installation, operation or safety of this product.

Battery Disposal

- Please ensure that used batteries are disposed of safely.
- Please do not dispose of batteries in a fire or with household waste.
- Please check with your local authority for disposal regulations.





User Guide

How Do I Dispose of This Product?



UK: Waste electrical products should not be disposed of with household waste. Separate disposal facilities exist, for you nearest facilities see www.recycle-more.co.uk or instore for details.



ROI: Produced after 13th August 2005

Waste electrical products should not be disposed of with household waste. Please recycle where facilities exist. Check with your Local Authority or retailer for recycling advice.

ELECTRICAL SAFETY

This appliance is fitted with a BS1363/A 13 amp plug. If it is not suitable for your supply sockets it must be removed and replaced with an appropriate plug. If the plug becomes damaged and/or needs to be replaced please follow the wiring instructions below.

The plug removed must be disposed of immediately.
It must not be plugged into a supply socket as this will be an electrical hazard.

If the fuse needs to be replaced it must be of the same rating and ASTA approved to BS1362. If the plug is changed, a fuse of the appropriate rating must be fitted in the plug, adapter or at the distribution board. If the fuse in a moulded plug is replaced, the fuse cover must be refitted before the appliance can be used.

 This symbol means this appliance is a class II appliance and therefore, an earth connection is not required.

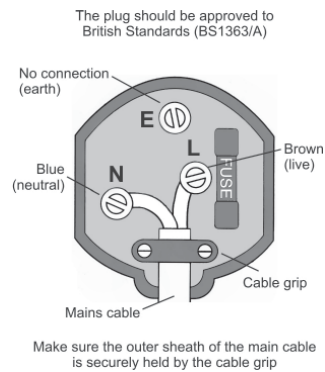



TECHNIKA

DVD Player DVDFAW08

PARTS IDENTIFICATION

Front View

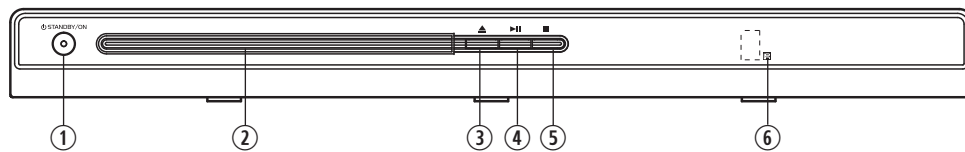

Rear View

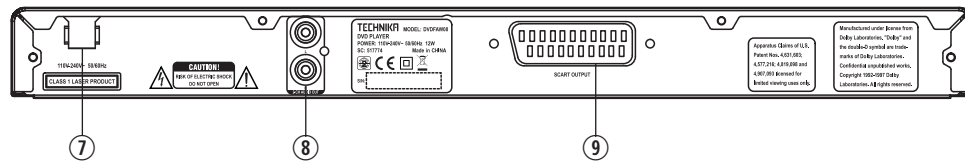

1. Standby On/Off
2. Disc Tray
3. Open/Close
4. Play/Pause
5. Stop

6. Remote Control Sensor
7. Mains Cable
8. 2 Channel Audio Output
9. SCART Output





User Guide

Remote Control

1. OPEN/CLOSE Opens and closes the disc tray
2. ANGLE Switches between camera angles
3. OSD Switches the On Screen Display (OSD) on or off
4. SUBTITLE Switches the subtitles on or off
5. TITLE/PBC Returns to the title menu of the disc
6. SEARCH Used to jump to a specific point on the disc
7. REPEAT Repeats chapter, track or title
8. A-B RPT Repeats a user defined section of the disc
9. SETUP Opens the setup menu
10. ARROWS Used to navigate the menu screens
11. ZOOM Enlarges or reduces the picture
12. F.REV Searches backwards during playback
13. F.FWD Searches forward during playback
14. PAUSE/STEP Pauses during playback and steps frame by frame
15. STOP Stops playback
16. VOLUME - Decreases the volume
17. STANDBY Switches the product on or off
18. NUMERIC BUTTONS
19. PAL/NTSC Selects the video output
20. CLEAR Clears the current entry in a menu
21. MENU Opens the root menu of the disc
22. PLAY Starts playback and confirms menu selections
23. PROG Programs playback in a user defined order
24. NEXT Skips to the next chapter/track
25. PREV Skips to the previous chapter/track
26. MUTE Turns the sound on or off
27. AUDIO Switches between audio modes
28. VOLUME + Increases the volume

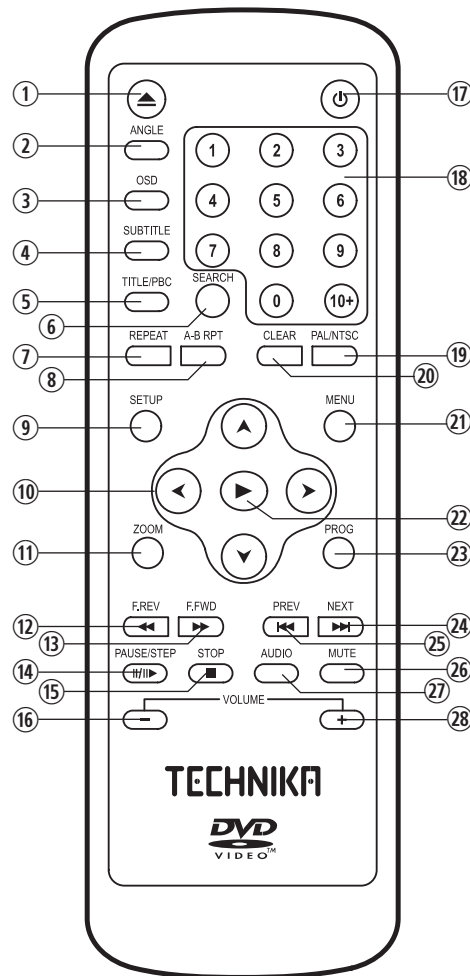

**TECHNIKA**

DVD Player DVDFAW08

GETTING STARTED

Connecting to the TV

The Quick Start Guide shows how to connect your DVD player to your television. These methods are described below.

SCART lead

The SCART lead (not supplied) should be used to connect your DVD player to your TV. This connection uses component video signals i.e. the red, green and blue (RGB) content of the video are sent as separate signals. This gives an excellent quality video signal.

RCA AV cable

The RCA AV Cable (not supplied) can be used to connect your DVD player to an external sound system such as your home stereo or a surround sound system. This connection method separates the left and right audio signals to provide superior quality sound.

The Remote Control

Installing the Remote Control Batteries

1. To remove the battery compartment cover, push the cover away from the remote control.
2. Place two AAA size batteries in the compartment following the battery polarity (+ and -) symbols indicated inside the battery compartment.
3. Replace the lid in position and press until it clicks shut.

Use of the Remote Control

To use the remote control, point it at the right hand front of the DVD player.

The remote control has a range of up to 6 metres from the DVD player and at an angle of up to + 30 and -30 degrees.

Do not block the path of the beam from the remote control to the DVD player.

NOTE: Sunlight or very bright light will reduce the remote control sensitivity.

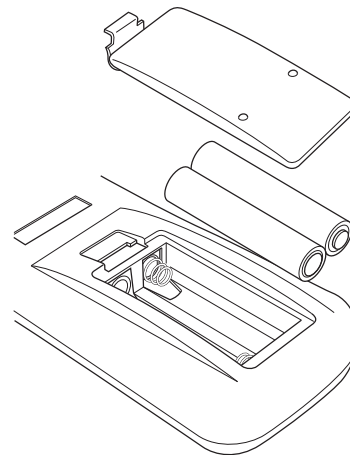



User Guide

Switching the DVD Player On and Off

Your DVD player requires a mains supply of 110-240 V AC at 50/60Hz. Please ensure that your mains supply is compatible.

1. Unwind the mains cable and insert the mains plug into the mains outlet socket and switch on.
2. To turn the DVD player on, press the **Standby On/Off** button on the front of the DVD player.

The **Standby** button on the Remote Control works in the same way as the **Standby On/Off** button on the front of the DVD player. The LED in the centre of the button will change from red to green.

Screen Saver

Television screens can sometimes be damaged by displaying stationary images for prolonged periods of time. To prevent this, the DVD player is equipped with an automatic screen saver to protect your television screen.

If the DVD player is in the stop mode and no buttons are pressed for approximately two minutes, the screen saver is displayed. The screen saver moves the TECHNIKA graphic around the screen.

Press any button on the remote control to deactivate the screen saver.



**TECHNIKA**

DVD Player DVDFAW08

INSERTING A DISC

Ensure the DVD player is connected to the mains supply and correctly connected to your television.

1. Press the **Standby On/Off** button on the front of your DVD player or alternatively the **Standby** button on the Remote Control. The screen displays the static TECHNIKA DVD logo.
2. Press the **Open/Close** button on the front of the DVD player or the Remote Control to open the DVD disc tray. In the top right of the TV screen, 'Open' will be displayed.
3. Place a compatible DVD disc into the recess on the disc tray, ensuring that the label is facing upwards. Place 8cm discs on the inner recess.
4. Press the **Open/Close** button on the DVD player or the remote control to close the disc drawer. In the top right of the TV screen, 'Close' will be displayed.

DVD

When the disc drawer has closed, 'Loading...' will be displayed on the TV screen followed by 'DVD'.

The DVD will automatically start to play and pause at the start of the disc menu to enable you to make any selections.

Audio CD

If an Audio CD has been inserted, after the screen loading message, the DVD player will automatically start to play the first audio track on the CD. The elapsed time and track number will be displayed on the TV screen.

Photo CD

If a Photo CD has been inserted, after the screen loading message, the DVD player will automatically display the first photo on the CD. The remaining photos on the CD will be played in a slide show. During the slide show a progress bar will be shown as each photo is loaded.



User Guide

Compatible Discs

Your DVD player can play discs that are marked with the following logos:



8cm/12cm DVD Video Discs.



12cm Compact Disc Recordable Discs.



12cm Compact Disc Re-Writable Discs.



8cm/12cm Compact Disc Audio Discs.



12cm Photo Compact Discs.



Kodak Picture Compact Discs.

Region code

If the region code of the disc being played does not match the region code of this DVD player then the disc cannot be played. If you do try to do this a region violation notice will appear on the screen.

The region code for this player is region 2 (refer to the symbols below).



**TECHNIKA**

DVD Player DVDFAW08

DVD PLAYER FUNCTIONS

NOTE: Unless otherwise stated, all references to buttons refer to the remote control.

Playing DVDs

When you load a DVD it will start to play automatically, most will stop at the Title menu. This enables you to select from various play options, such as different titles, trailer, and language options. The options available are dependent on the DVD. Normally you will need to press the **Play** button.

Pause Play

1. Press the **Pause/Step** button to pause play. In the top right of the TV screen, 'II' will be displayed.
2. To resume normal play, press the **Play** button. In the top right of the TV screen, '▶' will be briefly displayed.

Stop Play

1. Press the **Stop** button to stop play. The static TECHNIKA DVD logo is displayed.
2. Press the **Play** button to resume play. In the top right of the TV screen, 'Resume' will be briefly displayed.

NOTE: Play will commence from the exact position where the DVD was stopped, unless either the DVD disc has been removed from the player or the **Stop** button is pressed a second time.

Fast Forward/Reverse

You can fast search the contents of a DVD during playback.

1. Press either the **F.FWD** button, to fast forward through the disc or the **F.REV** button, to search backwards through the disc.
2. Each press of the **F.FWD** or **F.REV** button steps through the five available speeds. These are x2, x4, x8, x16 and x32 normal play speed. The set speed will be displayed on screen after each press of the button as '▶▶2x', '▶▶4x', '▶▶8x', '▶▶16x' or '▶▶32x' for fast forward and '◀◀2x', '◀◀4x', '◀◀8x', '◀◀16x' or '◀◀32x' for fast reverse.
3. Press the **Play** button at any time while fast forwarding or fast reversing to return to normal playing speed. In the top right of the TV screen, '▶' will be briefly displayed.





User Guide

Skip to the Next/Previous Chapter

You can skip to the next or previous chapter during playback.

1. Press the **Next** button to skip to the next chapter. Playback continues at the beginning of the next chapter and '▶▶I' will be briefly displayed in the top right of the screen.
2. Press the **Prev** button to skip to the beginning of the current chapter. Playback continues at the beginning of the current chapter and 'I◀◀' will be briefly displayed in the top right of the screen.
3. Pressing the **Prev** button again will skip to the previous chapter. Playback continues at the beginning of the previous chapter and 'I◀◀' will be briefly displayed in the top right of the screen.

Step

The Step function allows you to advance through the program one frame at a time.

1. Press the **Pause/Step** button to pause playback.
2. While playback is paused, press the **Pause/Step** button to advance playback by one frame. Repeatedly press the **Pause/Step** button to continue advancing by one frame.
3. To return to normal playback, press the **Play** button.

Mute

The audio outputs from the DVD player can be muted at any time by pressing the **Mute** button.

1. Press the **Mute** button to mute the sound output. In the top left of the TV screen, the mute symbol will be briefly displayed.
2. To restore sound output, press the **Mute** button again. In the top left of the TV screen, the mute off symbol will be briefly displayed.

Volume

The volume of the DVD player can be adjusted by pressing the **Volume +** and **Volume -** buttons.

PAL/NTSC

The correct TV System should be chosen to ensure the optimum picture quality. The available TV Systems are PAL, NTSC and Auto.

1. Press the **PAL/NTSC** button. In the top right of the TV screen, the current TV System will be displayed.
2. To change the TV System, press the **PAL/NTSC** button again. In the top right of the TV screen, the new TV System will be displayed. Repeatedly pressing the **PAL/NTSC** button will cycle through the available TV Systems.



**TECHNIKA**

DVD Player DVDFAW08

SPECIAL DVD FUNCTIONS

NOTE: *The functions described in the following sections may not be supported on all DVD discs. Refer to the DVD packaging for details of supported features and availability of languages and subtitles etc.*

Menu

The DVD main menu provides numerous playback, setup and language options.

1. To access the DVD main menu, press the **Menu** button at any time during playback. In the top right of the TV screen, 'Root Menu' will be briefly displayed before the main menu appears.
2. Press the **Arrow** buttons to navigate the DVD main menu and press the **Play** button to select an option.

Title

1. To return to the first title of the DVD at any time during playback, press the **Title/PBC** button. In the top right of the TV screen, 'Title Menu' will be briefly displayed before the title menu appears.
2. Press the **Arrow** buttons to navigate the title menu and press the **Play** button to select an option.

Subtitles

Some DVD discs contain subtitles in several languages.

1. To display the subtitles, press the **Subtitle** button. In the top left of the TV screen, the word 'Subtitle' will be displayed followed by the current language.
2. To change the subtitle language, repeatedly press the **Subtitle** button until the desired language is displayed in the top left of the TV screen.

The selected language will appear on screen shortly after selection.

NOTE: *The **Subtitle** button overrides any selections made in the setup menus.*

Audio

Some DVD discs contain audio tracks and audio commentaries in several languages.

1. To change the audio track, press the **Audio** button. In the top left of the TV screen, the following audio panel will be displayed.

 : Dolby D 5.1CH English 1/1

2. Repeatedly press the **Audio** button until the desired audio track is displayed in the top left of the TV screen.

The selected audio track will be heard shortly after selection.





User Guide

NOTE: The **Audio** button overrides any selections made in the setup menus.

Zoom

The Zoom function allows you to magnify the picture displayed on the TV screen.

1. Press the **Zoom** button to magnify the picture.
2. Each press of the **Zoom** button steps through the three available magnifications. These are x2, x4 and Off. The magnification will be displayed in the top right of the TV screen after each press of the button as 'Zoomx2', 'Zoomx4' and 'Zoom Off'.
3. When using the Zoom function, you can move around the picture using the **Arrow** buttons. 'Move Up', 'Move Down', 'Move Right', 'Move Left' is displayed.
4. To cancel the Zoom function, repeatedly press the **Zoom** button until 'Zoom Off' is displayed.

Search

You can search to a specific point in the DVD by either defining the title, chapter or the elapsed time.

Title Search

1. To perform a title search, press the **Search** button. In the top left of the TV screen, the following search panel will be displayed.



2. Press the **Up** or **Down Arrow** button to change the title number. Alternatively, enter the title number using the **Numeric** buttons.
3. Once the desired title number is displayed, press the **Play** button. Playback of the selected title will begin.

Chapter Search

1. To perform a chapter search, press the **Search** button. In the top left of the TV screen, the following search panel will be displayed.



2. Press the **Right Arrow** button to highlight the chapter number. This is shown in the search panel below.



3. Press the **Up** or **Down Arrow** button to change the chapter number. Alternatively, enter the chapter number using the **Numeric** buttons.
4. Once the desired chapter number is displayed, press the **Play** button. Playback of the selected chapter will begin.





TECHNIKA

DVD Player DVDFAW08

Elapsed Time Search

1. To perform an elapsed time search, press the **Search** button twice. In the top left of the TV screen, the following search panel will be displayed.



2. Using the **Numeric** buttons, enter the elapsed time. This should be in an Hours, Minutes and Seconds format. For example to enter a time of 1 hour, 25 minutes and 20 seconds, press the **1** button followed by the **2**, **5**, **2**, and **0** buttons.
3. Press the **Play** button. Playback from the specified elapsed time will begin.

Angle

Some DVD movie scenes are filmed using different camera angles and these may be included on the DVD disc. These can be viewed using the Angle feature.

1. Press the **Angle** button repeatedly to cycle through the available camera angles.

NOTE: Once a camera angle is selected using the Angle function, this camera angle will remain until changed or the DVD disc is removed from the DVD player.

Repeat

The Repeat function allows you to automatically replay the current title or chapter.

1. Each press of the **Repeat** button cycles through the available repeat options. These are Title, Chapter, All and Off.
2. To repeat a chapter, press the **Repeat** button once. In the top right of the TV screen 'Chapter' will be displayed.
3. To repeat a title, press the **Repeat** button twice. In the top right of the TV screen 'Title' will be displayed.
4. To repeat the entire DVD, press the **Repeat** button three times. In the top right of the TV screen 'All' will be displayed.
5. To cancel the repeat function, press the **Repeat** button until 'Off' is displayed in the top right of the TV screen.

A-B Repeat

The A-B Repeat function allows you to specify a section of the DVD to be replayed. Replay of the selected section will continue until the A-B Repeat function is cancelled.

1. During playback of the DVD disc, press the **A-B RPT** button at the start point of the section to be repeated. In the top right of the TV screen 'A' will be displayed.
2. At the end point of the section to be repeated, press the **A-B RPT** button again. In the top right of the TV screen 'A-B' will be displayed. The selected section of the DVD disc will be repeatedly played.
3. To cancel the A-B Repeat function and return to normal playback, press the **A-B RPT** button a third time. In the top right of the TV screen 'Off' will be displayed.





User Guide

On Screen Display (OSD)

The OSD provides information on the current title, chapter, time, audio track and subtitles.

1. Press the **OSD** button to show the OSD. The OSD appears in the top of the TV screen as shown below.



2. Press the **OSD** button repeatedly to cycle through the following OSD information.
 - Title time elapsed
 - Title time remaining
 - Chapter time elapsed
 - Chapter time remaining
 - Current Subtitle and Audio Track
3. To remove the OSD, repeatedly press the **OSD** button until the OSD disappears from the TV screen.

Program

The Program function can be used to play selected chapters in a specific order. Up to 20 chapters can be programmed at any one time.

NOTE: It is possible to program a chapter more than once.

1. Press the **Prog** button to access the program menu. The program menu will be displayed as shown below.

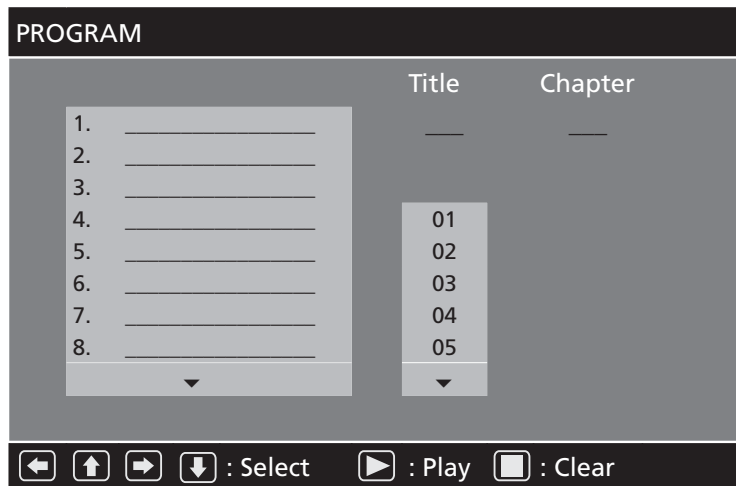

2. Press the **Up** or **Down Arrow** button to select the first programmable slot.
3. Press the **Right Arrow** button to program the title.



**TECHNIKA**

DVD Player DVDFAW08

4. Press the **Up** or **Down Arrow** button to select the title number.
5. Press the **Right Arrow** button to program the chapter.
6. Press the **Up** or **Down Arrow** button to select the chapter number.
7. Press the **Play** button to set the first programmable slot.
8. Repeat steps 2 through 7 to program the next slots.
9. If you make a mistake while programming a slot, press the **Clear** button to delete your selections.
10. Press the **Play** button to begin playback of the programmed chapters.
11. To cancel the Program function, press the **Stop** button twice at any time.

NOTE: If the DVD disc is removed from the DVD player, the Program function will be cancelled.

PLAYING AUDIO CDs

Loading Audio CDs

1. Press the **Standby** button. The screen displays the static TECHNIKA DVD logo.
2. Press the **Open/Close** button to open the DVD disc tray. In the top right of the TV screen, 'Open' will be displayed.
3. Place a compatible CD into the recess on the disc tray, ensuring that the label is facing upwards.
4. Press the **Open/Close** button to close the disc drawer. In the top right of the TV screen, 'Close' will be displayed.

Selecting Tracks

1. To select a specific track, enter the track number using the **Numeric** buttons. In the top right of the TV screen the track number will be displayed.
2. Press the **Play** button to begin playing the selected track. Alternatively, wait five seconds and it will automatically start.
3. To select the next track on the CD, press the **Next** button.
4. To select the previous track on the CD, press the **Prev** button.

Control During Playback

The Volume, Mute, Play, Stop, Fast Forward and Fast Reverse functions operate in the same way as described for DVDs.





User Guide

Repeat

The Repeat function allows you to automatically replay a specific track or the entire CD.

1. Each press of the **Repeat** button cycles through the available repeat options. These are Track, All and Off.
2. To repeat a Track, press the **Repeat** button once. In the top right of the TV screen '↻ Track' will be displayed.
3. To repeat the entire CD, press the **Repeat** button twice. In the top right of the TV screen '↻ All' will be displayed.
4. To cancel the repeat function, press the **Repeat** button until '↻ Off' is displayed in the top right of the TV screen.

A-B Repeat

The A-B Repeat function operates in the same way as described for DVDs. See page 16.

Program

The Program function can be used to play selected tracks in a specific order. Up to 20 tracks can be programmed at any one time.

NOTE: It is possible to program a track more than once.

1. Press the **Prog** button to access the program menu. The program menu will be displayed as shown below.



2. Press the **Up** or **Down Arrow** button to select the first programmable slot.
3. Press the **Right Arrow** button to program the Track.
4. Press the **Up** or **Down Arrow** button to select the Track number.
5. Press the **Play** button to set the first programmable slot.



**TECHNIKA**

DVD Player DVDFAW08

6. Repeat steps 2 through 5 to program the next track.
7. If you make a mistake while programming a slot, press the **Clear** button to delete your selections.
8. Press the **Play** button to begin playback of the programmed tracks.
9. To cancel the Program function, press the **Stop** button twice at any time.

NOTE: If the CD is removed from the DVD player, the Program function will be cancelled.

Search

You can search to a specific point in the CD by defining the elapsed time.

1. To perform an elapsed time search, press the **Search** button. In the top left of the TV screen, the following search panel will be displayed.



2. Using the **Numeric** buttons, enter the elapsed time. This should be in an Hours, Minutes and Seconds format. For example to enter a time of 25 minutes and 20 seconds, press the **0** button followed by the **2**, **5**, **2**, and **0** buttons.
3. Press the **Play** button. Playback from the specified elapsed time will begin.



PLAYING PHOTO CDS



The DVD Player allows you to view the photos of 12 cm Photo Compact Discs or Kodak Picture Compact Disc.

Loading Photo CDs

1. Press the **Standby** button. The screen displays the static TESCO DVD logo.
2. Press the **Open/Close** button to open the DVD disc tray. In the top right of the TV screen, 'Open' will be displayed.
3. Place a compatible Photo CD into the recess on the disc tray, ensuring that the label is facing upwards.
4. Press the **Open/Close** button to close the disc drawer. In the top right of the TV screen, 'Close' will be displayed.
5. After the 'loading' message disappears, the first photo will automatically be displayed. The remaining photos on the Photo CD will be shown in sequence in a slide show. A progress bar will appear in the top left hand corner of the screen as each image or photo is loaded.





User Guide

Accessing the Photo CD contents

The files and folders on the Photo CD can be accessed at any time, allowing you to browse and locate specific images or photos.

1. Press the **Menu** button to access the root menu of the Photo CD. The root menu will be shown as displayed below.
2. Press the **Left** and **Right Arrow** buttons to switch between the folder pane on the right hand side of the screen and the contents pane on the left hand side of the screen.
3. Press the **Up** or **Down Arrow** buttons to highlight a folder.
4. Press the **Play** button to list the photos of a selected folder in the contents pane.
5. Press the **Right Arrow** button to highlight the first photo in the contents pane.
6. Press the **Up** or **Down Arrow** buttons to highlight a specific photo. A thumbnail of the selected photo will be displayed in the bottom left hand corner of the screen.
7. Press the **Play** button to display the photo. The selected photo will be displayed full screen.

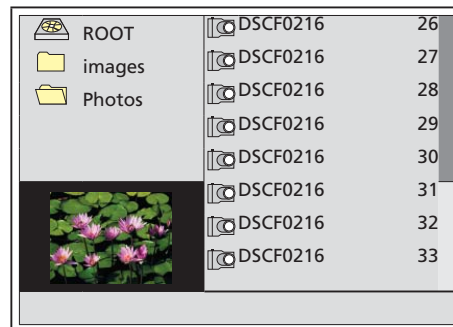

Control During Playback

Once a slideshow has started, each photo will be displayed at 5 second intervals until all the photos have been displayed.

Stopping a Slide Show

1. Press the **Menu** button at any time during the slide show to return to the root menu.

Pause a slide show

1. Press the **Pause/Step** button at any time to pause the slide show.
2. Press the **Play** or **Pause/Step** button to resume the slide show.

Repeat

The Repeat function allows you to replay the contents of the current folder or a single photo.

1. Each press of the **Repeat** button cycles through the available repeat options. These are Track and All.
2. To repeat a photo, press the **Repeat** button once. In the top right of the TV screen 'Track' will be displayed.
3. To repeat a folder, press the **Repeat** button twice. In the top right of the TV screen 'Folder' will be displayed.
4. To cancel the repeat function, press the **Repeat** button until 'Off' is displayed in the top right of the TV screen.





TECHNIKA

DVD Player DVDFAW08

Image Manipulation

The Image Manipulation feature allows you to rotate the displayed photo in 90 degree steps clockwise or anti-clockwise or flipped horizontally or vertically.

1. Press the **Right Arrow** button to rotate the photo 90 degrees clockwise. In the top right hand corner of the screen, 'Rotate Right 90°' will be displayed.
2. Press the **Left Arrow** button to rotate the photo 90 degrees anti-clockwise. In the top right hand corner of the screen, 'Rotate Left 90°' will be displayed.
3. Press the **Up Arrow** button to flip the photo horizontally. In the top right hand corner of the screen, 'Flip Horizontally' will be displayed.
4. Press the **Down Arrow** button to flip the photo vertically. In the top right hand corner of the screen, 'Flip Vertically' will be displayed.
5. Photos can be rotated or flipped as many times as required.

Zoom

The Zoom function allows you to increase or decrease the size of the photo. While a photo size is increased, you can move around the zoomed photo to view any areas which are not displayed.

1. Press the **Zoom** button repeatedly to cycle through the available zoom factors.
2. Each press of the **Zoom** button increases or decreases the zoom factor. The available zoom factors in sequence are: 100%, 150%, 200%, 25% and 50%. In the top right hand corner of the screen, the zoom factor will be displayed as '150%' etc.
3. Press the **Left Arrow** button while a photo is zoomed, to move the photo to the left.
4. Press the **Right Arrow** button while a photo is zoomed, to move the photo to the right.
5. Press the **Up Arrow** button while a photo is zoomed, to move the photo up.
6. Press the **Down Arrow** button while a photo is zoomed, to move the photo down.
7. To return the photo to its original size, press the **Play** button.

SETUP MENUS

Basic Controls

1. Ensure that the DVD player does not have a disc inserted. Press the **Setup** button to access the Setup menus.
2. Press the **Up** or **Down Arrow** button to scroll through the available Setup menus. Each setup menu will be shown with the currently available sub menus.
3. Press the **Right Arrow** button to access the sub menus. Each sub menu will be shown with the currently available options.
4. Press the **Up** or **Down Arrow** button to highlight and select an option in a sub menu.
5. Press the **Play** button to select a highlighted option.
6. Press the **Left Arrow** button to return to the previous menu.
7. To exit the Setup menus, press the **Setup** button again or alternatively highlight and select 'Exit Setup Mode' from the Setup menu.





User Guide

Language Setup

The Language Setup menu allows you to select the language options for the OSD and the DVD Menu, audio track and subtitles.

OSD

This menu allows you to set the OSD language. The available options are:

- English
- Polish
- Czech
- Slovak
- Hungarian
- Turkish

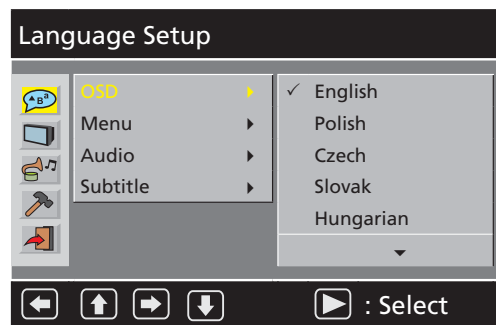

Menu

This menu allows you to set the DVD menu language. The available menu languages will be dependent on the DVD disc loaded.



Audio

This menu allows you to set the DVD audio language. The available audio language will be dependent on the DVD disc loaded.





TECHNIKA

DVD Player DVDFAW08

Subtitle

This menu allows you to set the DVD subtitle language. The available subtitle languages will be dependent on the DVD disc loaded.

Screen Setup

The Screen Setup menu allows you to adjust the DVD player and TV screen settings to suit your viewing preferences.

TV Type

This menu allows you to set the aspect ratio to suit your TV. The available options are:

- 4:3 PS - Stretches a widescreen format to fill the entire screen (Pan and Scan).
- 4:3 LB - Standard 4:3 format (letterbox).
- 16:9 - Standard widescreen format.

Screen Saver

This menu allows you to turn the Screen Saver On or Off. If the screen saver is turned on, an animated image will appear on the screen when the DVD player has been left idle for a certain length of time.

TV System

This menu allows you to select the correct TV System for your TV to ensure the optimum picture quality. The available options are:

- NTSC - This option should be selected to view NTSC signals.
- PAL - This option should be selected to view PAL signals.
- Auto - This option should be selected if you are unsure of which TV System you are using.

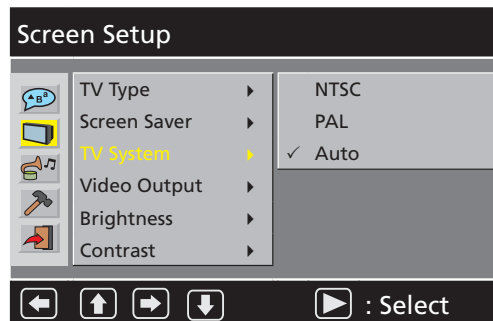
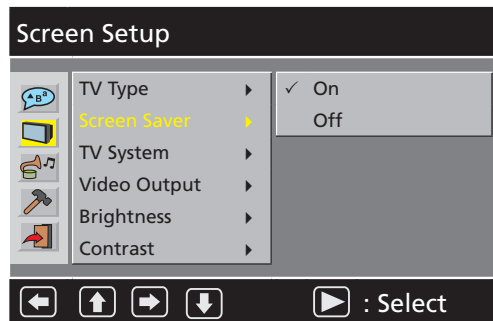
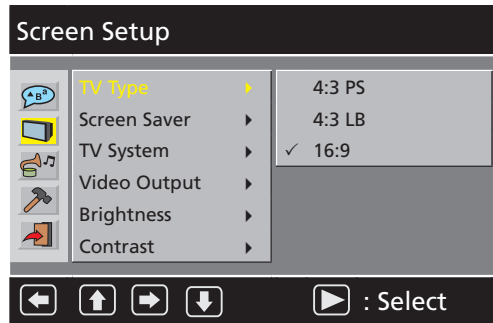



User Guide

Video Output

This menu allows you to select the video output type. The only option available is SCART.

Brightness

This menu allows you to select one of three brightness levels. The available options are:

- Normal - This option should be selected for viewing standard images.
- Bright - This option should be selected when viewing images with bright or strong colours.
- Soft - This option should be selected when viewing images with soft or weak colours.

Contrast

This menu allows the contrast to be set to suit your viewing preferences.

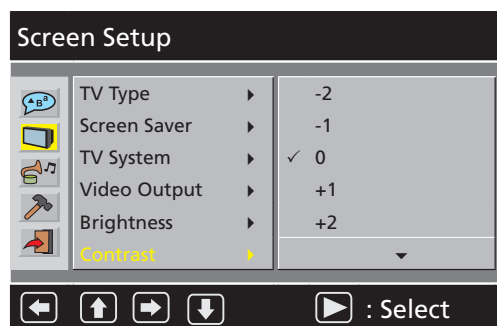
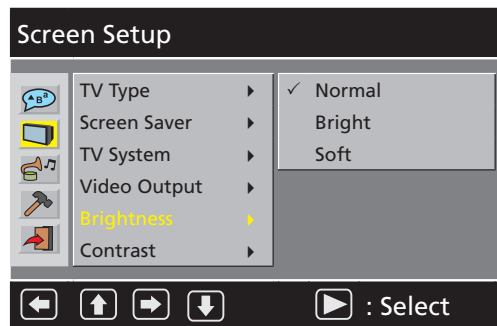
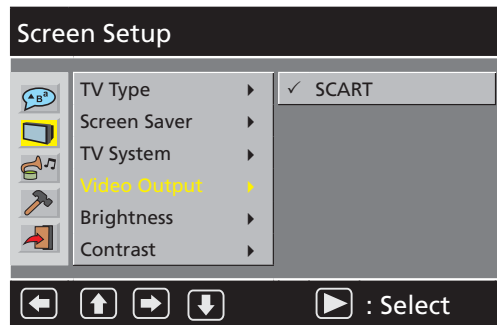



TECHNIKA

DVD Player DVDFAW08

Audio Setup

The Audio Setup menu allows you to adjust the audio output format.

Downmix

This menu allows you to select either Stereo output or Lt/Rt.

The Lt/Rt option should be set when the DVD player is connected to an external sound system such as a Stereo or Surround Sound System. When set, the left and right audio outputs are separated and sent to the external sound system individually.

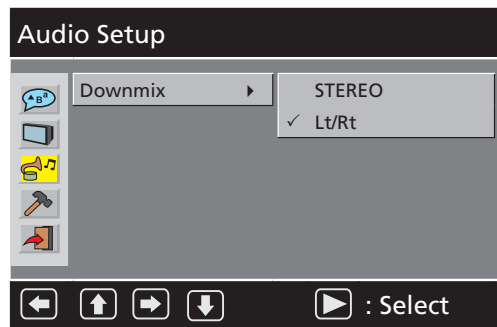

Custom Setup

The Custom Setup menu allows you to configure the general settings of the DVD player including Parental Control.

Parental Control

This menu allows you to set a suitable rating level to prevent playback of DVD discs which may be unsuitable for children.

The Parental Control feature requires a password to be entered. If you have not changed the password, this will be the default password. For more information on setting the password, refer to 'Password' on page 27.

NOTE: The Parental Control feature will only work if the DVD disc supports content rating. Refer to the DVD packaging for more information.

The available content ratings are:

- KID SAF
- G
- PG
- PG-13
- PGR
- R
- NC17
- ADULT





User Guide

Password

This menu allows you to set the Parental Control password.

1. To change the password, use the **Up** and **Down Arrow** buttons to highlight Password in the Custom Setup menu.
2. Press the **Right Arrow** button to set the password. The Password screen is displayed.
3. Using the **Numeric** buttons, enter the old password. The default password is '9922'.

NOTE: If the password is entered incorrectly, 'Wrong Password' will be displayed.

4. Using the **Numeric** buttons, enter the new four digit password.
5. Using the **Numeric** buttons, verify the new four digit password.

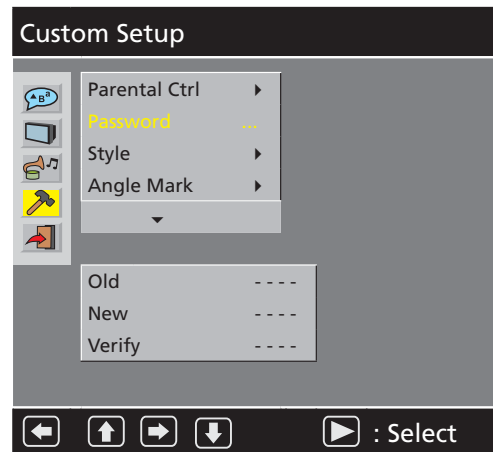

Style

This menu allows you to choose the colour scheme for the Setup menus. There are four styles to choose from each with a different variety of colours.

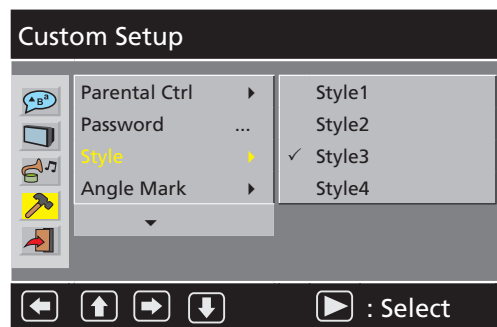

Angle Mark

This menu allows you to turn the angle mark on or off. The angle mark provides a visual indication when multiple angles are available during playback of a DVD disc.

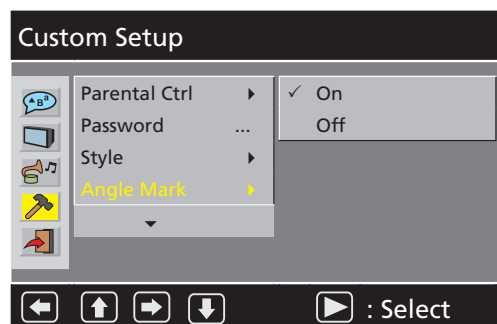



TECHNIKA

DVD Player DVDFAW08

Default

This menu allows you to reset the DVD player to the default factory settings.

NOTE: It does not change the Password or Parental Control settings.

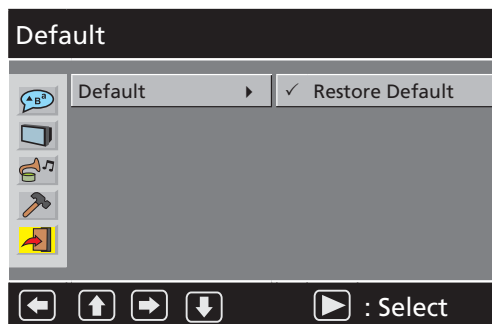

HELP AND ADVICE

Problem	Probable cause
The DVD player will not power up.	Ensure that the plug is connected to the mains socket and switched on. Replace the fuse in the plug.
Disc does not play.	Check that the disc has been correctly loaded, label facing up. Check that the format of the disc is supported. If it is a DVD disc, ensure that it is Region 2.
No picture.	Ensure that the DVD player and TV are powered on. Check that the cables are fitted securely. Ensure that the TV has the AV channel or equivalent selected. Try a DVD disc that you know plays.
No sound.	Check that the volume has not been set low on the TV. Check that the volume has not been muted on either the TV or DVD player. Check that the cables are fitted securely.
The picture quality is poor.	Check that the disc surface has not been damaged. Try cleaning the disc. Check that the cables are fitted securely.
Some functions do not work (e.g. Angle, Search etc.)	Refer to the DVD packaging. Not all functions are available.
No response to Remote Control.	Remote Control not aimed correctly. The Remote Control Sensor is obstructed. Remote Control batteries inserted incorrectly. Remote Control batteries exhausted.
If none of the above suggestions seem to work, try switching your DVD player off and then on again. If this does not work, contact either your supplier or a qualified repair technician. Never attempt to repair your DVD player yourself. Tesco Electrical Helpline: 0845 456 6767	





User Guide

CARE AND MAINTENANCE

Handling Discs

- To remove a disc from its storage case, press down on the centre of the case and lift the disc out.
- Discs should be returned to their cases after use. This avoids serious scratches that could cause the laser pickup to skip.
- Hold the disc by the edges, to avoid touching the recorded side of the disc.
- Fingerprints and dust should be carefully wiped from the disc's surface with a soft cloth.
- Never use chemicals such as record sprays, antistatic sprays, benzene, or thinners to clean the discs. These chemicals can irreparably damage the disc's surface.
- Audio discs and DVD discs have no grooves to collect dust and microscopic debris so gently wiping with a soft cloth should remove most particles.
- Wipe in a straight line from the inside to the outside of the disc. Small dust particles and light stains should have no effect on reproduction quality.
- Do not expose discs to direct sunlight, high humidity, or high temperatures for extended periods. Exposure to high temperatures can warp the disc.
- Do not stick paper or write anything with a ball point pen on the label side of the disc.



**TECHNIKA**

DVD Player DVDFAW08

TECHNICAL SPECIFICATION

Power Supply	110-240V AC at 50/60Hz
Power Consumption	12W
Physical Disc Sizes	12cm and 8cm
Video Signal System	PAL and NTSC

WARRANTY

Your Tesco appliance is covered by a warranty for 12 months from the date of purchase. If a fault develops during this period, please contact the Tesco electrical help line on 0845 456 6767. Please have your original purchase receipt with you when you call. This warranty in no way affects your consumer rights.





User Guide





TECHNIKA



UK

TESCO Stores Ltd, Cheshunt, EN8 9SL, UK.

